

rothe erde[®] slewing bearings

Installation
Lubrication
Maintenance

Bearing Inspection



thyssenkrupp



Content

Installation · Lubrication · Maintenance (ILM)	4
Bearing Inspection	12
Safety and warning instructions	
Installation · Lubrication · Maintenance (ILM) / Bearing Inspection	20
Sicherheits- und Warnhinweise	
Einbau · Schmierung · Wartung (ESW) / Lagerinspektion	21
Consignes de sécurité et avertissements	
Montage · Graissage · Entretien (MGE) / Inspection des couronnes	22
Instrucciones de seguridad y de advertencia	
Montaje · Lubricación · Mantenimiento (MLM) / Inspección de rodamiento	23
Instruções de segurança e avisos	
Montagem · Lubrificação · Manutenção (MLM) / Inspeção de rolamentos	24
Avvertenze e norme di sicurezza	
Montaggio Lubrificazione Manutenzione (MLM) / Ispezione dei cuscinetti	25
Veiligheids- en waarschuwingeninstructies	
Montage · Smering · Onderhoud (MSO) / Lagerinspectie	26
Biztonsági előírások és figyelmeztetések	
Beszereles · Kenés · Karbantartás (BKK) / Csapágy inspekció	27
Инструкции по технике безопасности и предупредительные указания	
Монтаж · Смазка · Техобслуживание (МСТ) / Инспекция подшипников	28
安全与警告说明	
安装 · 润滑 · 维护保养 / 支承检测	29
安全上の注意及び警告	
取り付け・潤滑・メンテナンス / ベアリング点検	30
ةيالسنا تآا يهعجو تازيذحنا	
لمحمل ةنواعم (ILM) / ةنواعم الـ ميحشـتلا ـ بيكرتلا	31

Installation · Lubrication · Maintenance (ILM)

Does not apply to bearings with specific ILM instructions – for replacement deliveries it is essential to get into contact with the machine manufacturer regarding installation, lubrication and maintenance.

thyssenkrupp rothe erde Germany GmbH offers an extensive slewing bearing service (see catalogue "rothe erde® slewing bearings" chapter Service or www.thyssenkrupp-rotheerde.com -> Products and Service).

Transport and handling

! DANGER

Danger of life by overhead load

- Do NOT step underneath the load
- Use suitable slings
- Use suitable lifting devices
- Suitable transport tap hole are stated in the bearing drawing

Slewing bearings, like any other part of a machine, require careful handling. They should always be transported and stored in horizontal position. For safe handling of bearings which include transport holes, high tensile lifting eye bolts must be used. In special cases an internal cross bracing (transporting cross) is required. The bearing weight must be indicated on the crate or pallet. Impact loads, particularly in a radial direction, must be avoided.

Delivery condition

Raceway system
The slewing bearings are delivered filled with one of the greases (see table 3 on page 9) unless no special lubricant and special grease quantities are required.

External contours

The external contours of the bearings (except for holes) have Cortec VCI corrosion protection applied.

Gearing

The gearing is not greased. The corrosion protection is applied as for the external contours.

Storage

ATTENTION

Sensitive surface

- Do not open the packing with a sharp blade
- Surface may be damaged

Approx. 6 months in roofed storage areas.
Approx. 12 months in enclosed, temperature-controlled areas (temperature > 12°C).
Outside storage is not allowed.

If required, other corrosion protection agents and types of packaging can be used, e.g. long-term packaging for up to 5 years.

Longer storage periods will necessitate special preservation. After the slewing bearing has been stored for a relatively long time, an increased frictional torque may be observed caused by the suction adhesion of the sealing lip. Careful lifting of the sealing lip with a blunt object around the entire circumference and several clockwise and counterclockwise rotations of the slewing bearing through 360 degrees will reduce the frictional torque to normal.

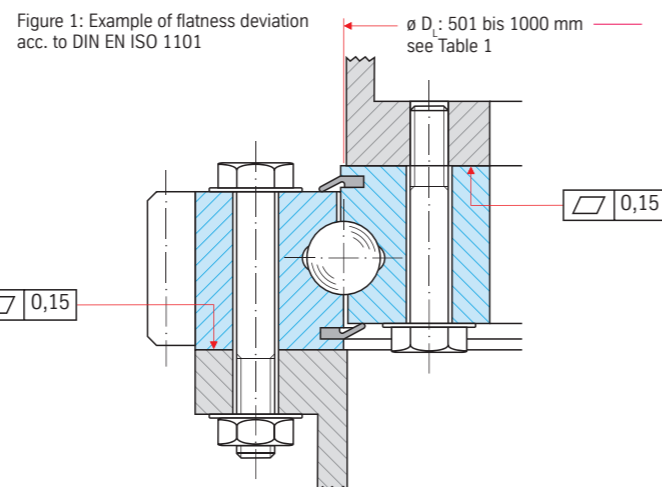

Installation

! CAUTION

Risk of skin irritation caused by preservative

- Safety gloves must be worn for removal
- Pay attention to the producer's data

A flat mounting surface free of grease and oil is essential for the upper and lower ring to seat firmly. Welding beads, burrs, excessive paint and other irregularities must be removed prior to installation. The bearing rings must be completely supported by the connecting structure.

! DANGER

Entrapment hazard when putting the load down

- Location control before putting the load down
- Mind the staff

thyssenkrupp rothe erde Germany GmbH recommends conducting a check on the mounting surfaces with a leveling instrument or laser equipment (this service can be provided by thyssenkrupp rothe erde Germany GmbH). The flatness values should not exceed the values shown in table 1. To avoid larger deviations and the occurrence of peaks in smaller sectors, any deviation in the range of 0°–180° may only rise evenly once and fall again.

Table 1: Permitted evenness deviation acc. to DIN EN ISO 1101 on the support surfaces

Track \varnothing in mm D_L	Evenness acc. to DIN EN ISO 1101 per support surface in mm for		
	BF 01 Double-row ball bearing slewing rings BF 08 Axial ball bearings	BF 06 Single-row ball bearing slewing rings 4-point contact bearings BF 09 – Double 4-point contact bearings BF 25, 23, 28 profile bearings*	BF 19 BF 13 Roller slewing bearings BF 12 Combination bearings
up to 500	0,15	0,10	0,07
up to 1000	0,20	0,15	0,10
up to 1500	0,25	0,19	0,12
up to 2000	0,30	0,22	0,15
up to 2500	0,35	0,25	0,17
up to 4000	0,40	0,30	0,20
up to 6000	0,50	0,40	0,30
up to 8000	0,60	0,50	0,40

The serial number relates to the first two places in the drawing number. The permitted values in table 1 are not allowed to be used for special configurations as high-precision bearings with high running accuracy and low bearing play, please contact thyssenkrupp rothe erde Germany GmbH : www.thyssenkrupp-rotheerde.com
*) Double these values are permitted for normal bearings BF 25, BF 23.

Installation · Lubrication · Maintenance (ILM)

Does not apply to bearings with specific ILM instructions – for replacement deliveries it is essential to get into contact with the machine manufacturer regarding installation, lubrication and maintenance.

Mechanical machining of the bearing connection surfaces on the connecting structure is required if the values are exceeded. The mounting position of slewing bearings must correspond to that shown in the drawing. If a transporting cross was delivered, it has to be removed before installation.

The corrosion protection can be removed with an alkaline cleaner. Cleaner must be prevented from coming into contact with the seals or the raceway. Remove the protective coating from the upper and the lower mounting surfaces of the slewing bearing as well as from the gear.

Note The corrosion protection can easily be removed, for example, using a biodegradable alkaline cleaner.

Advantage Rapid removal of the corrosion protection and low environmental impact.

Hardness gap

The unhardened zone between the beginning and the end of the hardened region of the raceway is marked with an "S" on the inner or outer diameter of each bearing ring. On the gear ring, the hardness gap is marked on the axial surface. Wherever possible, the hardness gap "S" must be positioned outside the main load-carrying areas. If the main working area for the application is known, then the hardness gap of the ring loaded on the circumference must also be positioned outside the main load-carrying area.

Commissionings

The bearing must be completely screwed on for commissionings and test runs. Sufficient load / moment load must be applied to avoid a slip-stick effect on the anti-friction bearing bodies.

Gearing



The backlash is adjusted relative to the three gear teeth marked in green and should be at least 0.03–0.04 x module. After the final tightening of the bearing, the backlash should be rechecked over the entire circumference. A tip edge radius and a tip relief must be provided on the pinion (see the "Gearing" chapter in the catalog rothe erde® slewing bearings or www.thyssenkrupp-rotheerde.com).

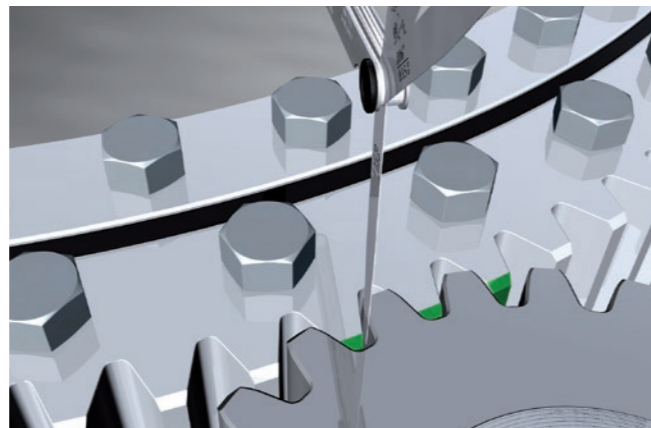

Figure 2: Backlash measurement

Table 2

Thread/ bolt diameters	Hole diameters mm	Tightening torques Nm for bolts in strength class $\mu_G \approx \mu_K = 0,14$	
		for hydr. + electr. M_d -torque wrench	for M_d -key
	DIN EN 20 273	10.9	10.9
M 12	14	137	123
M 14	16	218	196
M 16	17,5	338	304
M 18	20	469	422
M 20	22	661	594
M 24	26	1136	1022
M 27	30	1674	1506
M 30	33	2274	2046
		Grade 8	Grade 8
UNC t" –	11	286	260
UNC c" –	10	506	460
UNC u" –	9	803	730
UNC 1" –	8	1210	1100
UNC 1r" –	7	1716	1560
UNC 1b" –	7	2410	2190
		Grade 8	Grade 8
UNF t" –	18	320	290
UNF c" –	16	560	510
UNF u" –	14	902	820
UNF 1" –	12	1330	1210
UNF 1r" –	12	1936	1760
UNF 1b" –	12	2685	2440

Bolting/bolting assembly

Bolt holes on the bearing and connecting structure must match up, otherwise impermissible levels of stress will be established. Through-holes shall be configured acc. to DIN EN 20 273, medium series, – see table 2.

Installation · Lubrication · Maintenance (ILM)

Does not apply to bearings with specific ILM instructions – for replacement deliveries it is essential to get into contact with the machine manufacturer regarding installation, lubrication and maintenance.

Fastening bolts

Normal fastening bolts, nuts and washers (without surface treatment) in strength class 10.9 acc. to DIN ISO 267. It is essential to comply with the specified number and diameter. The bolts must be carefully preloaded crosswise to the specified values (table 2 on page 7 gives several recommended values). The surface pressure underneath the bolt head or nut must not exceed the permitted limit values (see the “Fastening bolts” chapter in the catalog rothe erde® slewing bearings or www.thyssenkrupp-rotheerde.com, also with regard to the minimum grip of the bolt). If the limiting surface pressure is exceeded, washers of the appropriate size and strength must be provided. The minimum length of engagement must be guaranteed in the case of blind hole threads. If a hydraulic tensioning device is used, it is essential to adhere to the required pro-

jections for the screw threads or stud bolt threads and to use the appropriate washers (see the “Bolts” chapter in the catalog rothe erde® slewing bearings or www.thyssenkrupp-rotheerde.com).

The determination of the tightening torque depends not only on the strength class of the bolt and the tightening process but also on the friction in the thread and the contact surface of the bolt head and nut. The tightening torques given in table 2 on page 7 are recommended values based on lightly oiled threads and contact surfaces.

Dry threads will require higher torques whilst heavily oiled threads will require lower tightening torques. The values may, therefore, vary considerably. This applies in particular to threads larger than M 30 or 1b”. For bolts of this size the use of bolt tensioning is recommended.

If the frictional bond is not adequate, it is advisable to use a suitable compound to increase the frictional bond, or else make a form-locking connection. Welding of slewing bearings is not permitted.

Note After prestressing the 8th bolt diagonally across, make one complete circuit. The prestressing of the bolt tightened first is influenced by tightening the other bolts. Therefore, it is necessary to provide at least two rotations.

Lubrication and Maintenance

All the grease nipples must be easily accessible, lubrication lines must be provided if necessary. thyssenkrupp rothe erde Germany GmbH recommends the installation of an automatic central lubricating system. The bearing system and the gearing must be greased immediately after installation. The lubricants specified in table 3 on page 9 are to be used for this and each subsequent lubrication. The only lubrication to be used on the raceway is KP2K grease, i.e. lithium saponified mineral oils of NLGI Grade 2 with EP additives. The raceway lubricants listed in table 3 can be mixed together. The lubricants are listed in alphabetical order. The grease fill prevents friction, provides protection against corrosion and is a component of the seal.

Therefore the bearing must always be greased liberally so that a collar of fresh grease forms around the whole circumference of the bearing gap and lip seals. This collar of grease must be removed regularly in order to prevent water building up. The bearing should be rotated during relubrication.

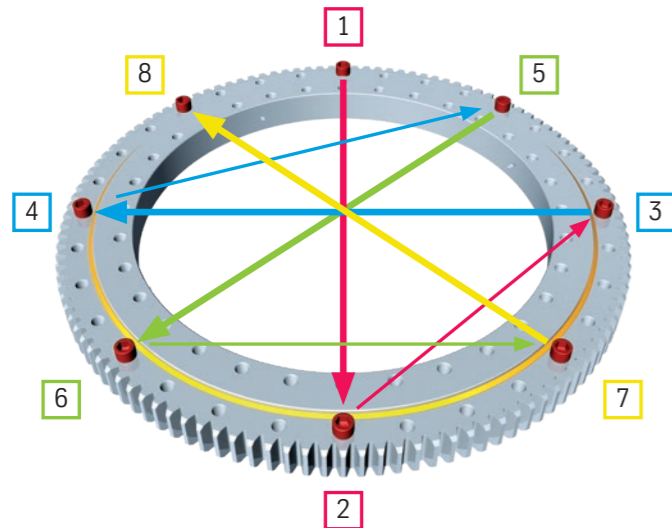

Figure 3: Tightening sequence of the fastening bolts

Table 3: Lubricants

	● Aralub HLP 2	243 K to 393 K (-30°C to +120°C)
	▲ Castrol Molub-Alloy OG 936 SF Heavy	243 K to 373 K (-30°C to +100°C)
	● Spheerol EPL 2	253 K to 413 K (-20°C to +140°C)
	▲ Castrol Molub-Alloy OG 9790/2500-0	253 K to 363 K (-20°C to +90°C)
	● Centoplex EP 2	253 K to 403 K (-20°C to +130°C)
	▲ Grafloscon C-SG 0 ultra	243 K to 473 K (-30°C to +200°C)
	● Lagermeister EP 2	253 K to 403 K (-20°C to +130°C)
	▲ Ceplattyn KG 10 HMF	263 K to 413 K (-10°C to +140°C)
	● Mobilux EP 2	253 K to 393 K (-20°C to +120°C)
	▲ Mobilgear OGL 461	253 K to 393 K (-20°C to +120°C)
	● Gadus S2 V220 2	248 K to 403 K (-25°C to +130°C)
	▲ Gadus S2 OGH NLGI 0/00	263 K to 473 K (-10°C to +200°C)
	● Multis EP 2	248 K to 393 K (-25°C to +120°C)
	▲ Copal OGL 0	248 K to 423 K (-25°C to +150°C)

● Raceway grease
▲ Gear grease

(Symbols see Figure 4 on page 10)

Lubricants

CAUTION

Risk of skin irritation caused by lubricants

- Safety gloves must be worn when handling lubricants
- Pay attention to the producer's data

Queries about lubricants should be directed to the respective manufacturer.

The greases listed in table 3 are approved for our slewing bearings and tested for compatibility with the materials which we use for our spacers and seals. The list of greases is not exhaustive.

Obtain confirmation of suitability from the lubricant manufacturer before using other lubricants. The properties must at least correspond to those of the greases listed in table 3, and compatibility with the materials we use must be assured. When automatic lubricating devices are used, the lubricant manufacturer must confirm that the lubricant selected is suitable for a “pumped” system. Special lubricants are necessary if the bearings are used in extreme temperatures.

Lubricants are contaminants. They must not be allowed to get into the ground, the groundwater, or into the water and sewage system.

Installation · Lubrication · Maintenance (ILM)

Does not apply to bearings with specific ILM instructions – for replacement deliveries it is essential to get into contact with the machine manufacturer regarding installation, lubrication and maintenance.

Relubrication of the raceway system

The bearing should be rotated during relubrication until a fresh collar of grease is seen to form around the whole circumference of the bearing gaps and lip seals. It is the responsibility of the maintenance personnel to ensure that the correct amounts of grease at individual regular intervals are administered to the bearing, determined by regular monitoring of the lubricated condition of both the bearing raceway and gear. The amount of lubrication will need to be increased and the lubrication intervals shortened in extreme conditions, e.g. in the tropics, where humidity levels (moisture) are raised, exposure to dust and dirt is high, and extreme temperature fluctuations prevail.

Bogie bearings for railway and tram vehicles as well as bearings for wind energy turbines are subject to special requirements, and thyssenkrupp rothe erde Germany GmbH should be contacted in such cases.

In the case of partially assembled bearings, or if there is a long period between bearing installation and equipment commissioning, then appropriate maintenance procedures will be required, e.g. relubrication under rotation or adequate slewing after no more than three months and thereafter every three months. Relubrication is absolutely essential before and after prolonged shut-down of the equipment. The bare metal bearing contours and holes must have corrosion protection applied, and must be checked regularly.

Cleaning the equipment

When cleaning the equipment, care must be taken to prevent cleaning agents or water from damaging the seals or penetrating into the raceways.

Lubrication intervals for the gear

We recommend automatic gear lubrication. This is because the tooth flanks should always have sufficient grease applied

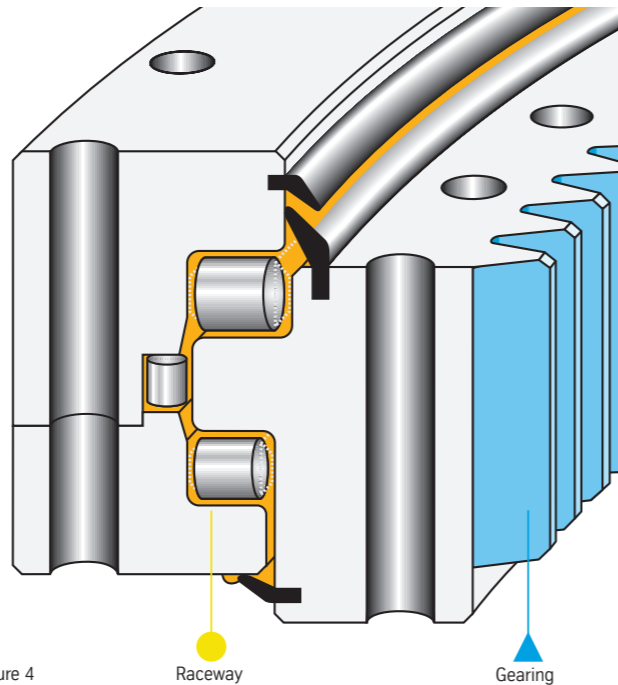

Figure 4

relative to both the application and the duty. It is the responsibility of the maintenance personnel to ensure that the correct amounts of grease at individual regular intervals are administered to the gearing, determined by regular monitoring of the lubricated condition.



Note Effective lubrication is essential for the raceway system and the gearing. This is the only way to achieve a satisfactory service life.

Advantage Optimum use of lubricant and intervals increase the availability of the system.

Examination of bolts

The bolted connection must be capable of maintaining a pre-designated preload during the entire life of the bearing. Experience has shown that it is advisable to check the bolt torques on a regular basis and to retighten the bolts to compensate for any settlement phenomena.

Checking of the raceway system

! DANGER		
	<p>Exceeding the maximum permissible wear rates involves the risk of accidents and danger of life</p> <ul style="list-style-type: none"> When reaching the wear limits the machine must be put out of operation 	
SAFETY INSTRUCTIONS		
<ul style="list-style-type: none"> While in operation it must be assured that the wear limits of the bearing will not be reached. With regard to further information (sketches/procedures) see www.thyssenkrupp-rotheerde.com. The resulting wear must be regularly determined and recorded The procedure is included in the manual In case of open questions thyssenkrupp rothe erde Germany GmbH must be contacted 		

When the bearing is put into operation, we recommend that tilting play or subsidence should be measured (see the "Bearing inspection" chapter in the catalog rothe erde® slewing bearings or www.thyssenkrupp-rotheerde.com). Make sure that the wear limits of the bearing are not reached. We recommend repeating this measurement at suitable intervals. In addition, a sample of the used grease can be taken for analysis.

Checking of the seal

Check seals at least every 6 months, renew the seal if it is damaged.

Inspecting the gearing

Gear teeth become smoothed and worn in the course of use. A permissible wear limit depends very much on the application. Experience indicates that a wear value of up to 0.1 x module per flank is permissible.

thyssenkrupp rothe erde Germany GmbH Service assistance

For a continuous and undisturbed operation of our bearings we offer our following service:

Installation

- Assessment of the contact surfaces/ laser measurement
- Bearing installation
- Reference measurement
- Commissioning

Maintenance and inspection

- Wear measurement
- Check of bolts
- Lubricant analysis
- Seal exchange

Reconditioning

- Repair
- General overhaul

Others

- Trainings
- Technical support

Bearing inspection

Preventing damage

Wear measurements enable early detection of technical problems before they result in unscheduled plant stoppages. Unnecessary repair costs and expensive production downtimes are thus avoided. We therefore recommend regular bearing wear measurements in order to assess the condition of a bearing.

The wear which affects the raceway system makes itself felt in a change of the axial motion or the axial reduction. Depending on the application or bearing version, this increase in wear can be determined by measuring the tilting clearance or by taking reduction measurements.

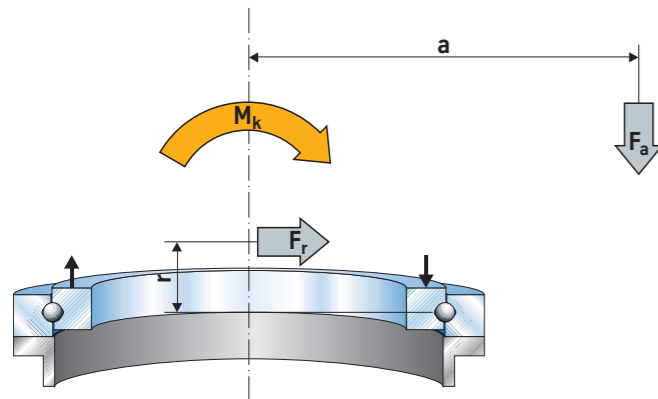

Figure 5: Loading principle of the tilting clearance measurement (axial motion)

Measuring the tilting clearance

To determine the wear, we recommend carrying out tilting clearance measurements wherever possible. The loading principle for such measurements is shown in figure 5.

The measurements are taken between the lower companion structure and the bearing ring which is bolted to the superstructure (figure 6). The measurements must be taken as close to the raceway system as possible in order to minimize the impact of elastic deformations in the companion structure.



Figure 6: Basic setup for measuring the tilting clearance

The procedure is as follows:

- Take a reference measurement when the equipment is put into operation.
- Mark the measuring points around the circumference starting from a defined position.
- First apply the maximum retrograde moment in order to set the dial gauges to zero (the gauges must have a measuring accuracy of 0.01 mm). Then apply a forward tilting moment, with load uptake if necessary.
- Swivel the superstructure and repeat the measurements at the marked measuring points (see table 7 on page 19).

Maximum permissible increase in bearing clearance (uniform wear)

These increases in bearing clearance are not permissible for special applications, e.g. 50% of the listed values for fairground ride slewing bearings (contact thyssenkrupp rothe erde Germany GmbH).

Table 4: Series* 01, 08 (double-row ball bearings/axial ball bearings)

Measuring method	Ball diameter mm										
	18	20	22	25	30	35	40	45	50	60	70
	max. permissible wear values up to mm										
Axial reduction measurement	1.8			2.2			3.0			3.8	
Tilting clearance measurement	2.5			3.0			4.0			5.0	

*see 1. and 2. figure of the drawing number

Table 5: Series* 06, 09, 25, 23, 28 (four-point bearings/profile bearings)

Measuring method	Ball diameter mm									
	20	22	25	30	35	40	45	50	60	70
	max. permissible wear values up to mm									
Axial reduction measurement	1.6		2.0			2.6			3.3	
Tilting clearance measurement	2.0		2.6			3.2			4.0	

*see 1. and 2. figure of the drawing number

Table 6: Series* 12, 13, 16, 19 (roller bearing slewing rings)

Measuring method	Roller diameter mm													
	16	20	25	28	32	36	40	45	50	60	70	80	90	100
	max. permissible wear values up to mm													
Axial reduction measurement	0.8			1.2			1.6			2.0			2.4	
Tilting clearance measurement	1.4			2.0			2.8			3.5			4.2	

*see 1. and 2. figure of the drawing number

Bearing inspection

Measuring the axial reduction

Where tilting clearance measurements are not possible we recommend the axial reduction measurement method. In this case the center of the load combinations lies within the race diameter of the bearing. The loading principle is shown in figure 7.

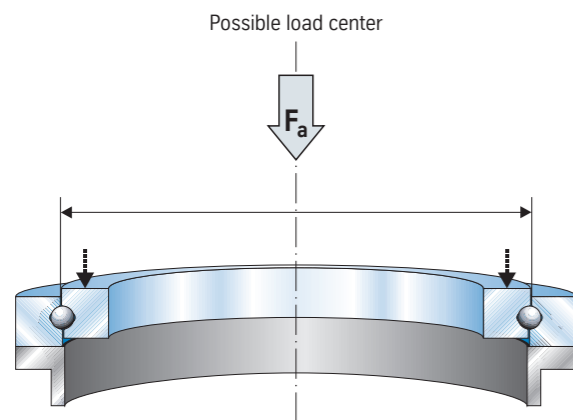

Figure 7: Loading principle of the axial reduction measurement

The measurements are taken between the lower companion structure and the bearing ring which is bolted to the superstructure (figures 8, 9). The procedure is similar to that for measuring the tilting clearance:

- Here too, record reference values when the equipment is put into operation.
- Mark the measuring points around the circumference starting from a defined position.

Repeat the tilting clearance or axial reduction measurements under the same conditions at appropriate intervals, after first checking the bearing fastening bolts. The difference between the current measurement and the reference measurement is the wear which has occurred in the intervening period. If the wear values show a rising trend, you should carry out the measurements more often.



Figure 8: Basic setup for measuring the axial reduction with a depth gauge

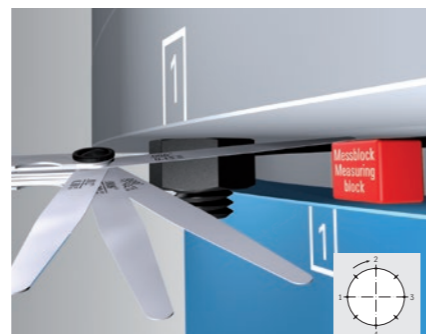

Figure 9: Basic setup for measuring the axial reduction with a feeler gauge

Advantage Given conclusive assessment of the bearing's condition, worn parts can be replaced in good time. In conjunction with optimum spare parts management, it is thus possible to avoid incidents of damage and lengthy downtimes.

Note If the permissible wear values (tables 4, 5 and 6 on page 13) are exceeded, we recommend that the equipment should be shut down.

The alternative:

IWM (integrated wear measuring device)

thyssenkrupp rothe erde Germany GmbH always focuses on developing innovative solutions for permanently monitoring the condition of a bearing in order to further optimize the function and reliability of plant operations. The integrated wear measuring device for slewing bearings is a patented invention which enables online inspection of the maximum permissible axial clearance or axial reduction of a slewing connection.

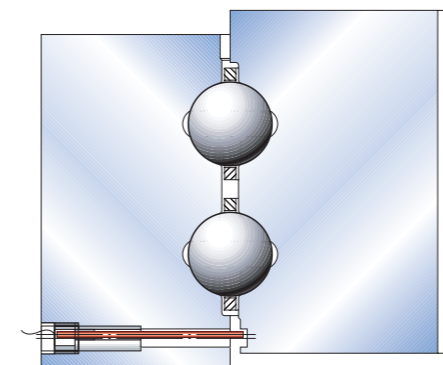

Figure 10

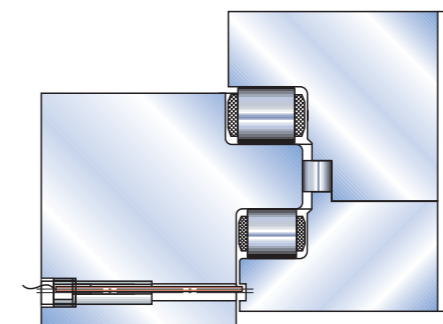

Figure 11

Advantage It is no longer necessary to interrupt operations in order to determine the axial clearance.

A pin made of stainless steel is located in the peak load area of the raceways. The electrically isolated pin is mounted in one ring and protrudes into a groove in the other ring. The maximum tolerated clearance can be adjusted by means of the groove width.

If the clearance changes by an impermissible amount, the ring and the pin will make contact with each other. The pin's electrical connection results in a signal being triggered when the pin touches the other ring. This signal indicates that the permissible relative movement of the rings has been reached and that it is time to inspect the bearing.

Advantage The deformation of the companion structure and the elasticity of the bolt connections do not significantly influence the measurement result. The elastic approximation of the raceways, the axial clearance of the bearing and the out-of-flatness of the contact surface are compensated. Costs for maintenance personnel are minimized.

Bearing inspection



Figure 12: Grease sampling set

Grease sampling set

Grease samples are taken in parallel with, i.e. at the same time as, the inspection measurements. The analysis of the used grease provides additional information about the raceway condition.

Bearings with grease sampling ports

CAUTION	
	<p>Risk of skin irritation caused by lubricants</p> <ul style="list-style-type: none"> • Safety gloves must be worn when handling lubricants • Pay attention to the producer's data

The grease sampling set comprises a plastic tube, various cap plugs, a suction device, a sample box for up to 5 grease samples, and an information sheet. The procedure is described in detail.

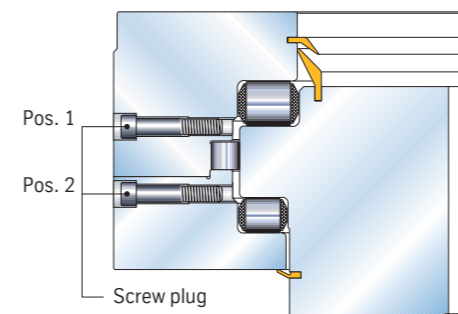

Figure 13: Three-row roller bearing slewing ring with grease sampling ports

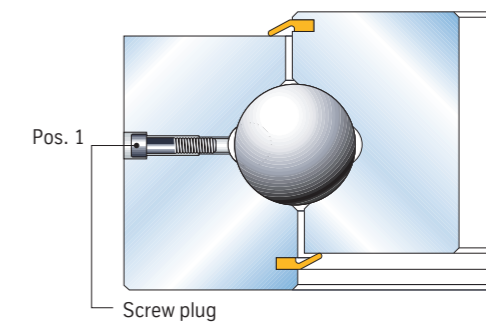

Figure 14: Single-row ball bearing with grease sampling port

Take the grease samples from the main loading zone.

The sampling ports must be closed again with the screw plugs.

Remove the screw plug (M16 EN ISO 4762) selected for taking the sample: position 1 and if necessary position 2 opposite (figures 13 and 14).

When the sample has been taken, close both tube ends with the plastic caps.

Number the grease sample and place it in the labeled sample box.

Before taking the grease sample, cut the supplied tube at an angle of 45° so that it is slightly longer than the grease sampling port. Then insert the tube into the raceway area of the port (figure 15).

Add the necessary information (see the grease sampling set in figure 12) to the top of the sample box.

Make sure that the surface cut at 45° faces in the opposite direction to the direction of rotation (figure 16).

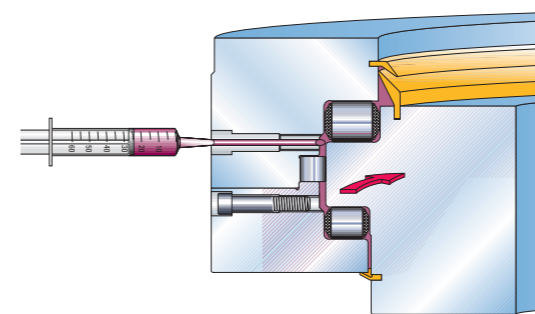

Figure 15: Taking a sample

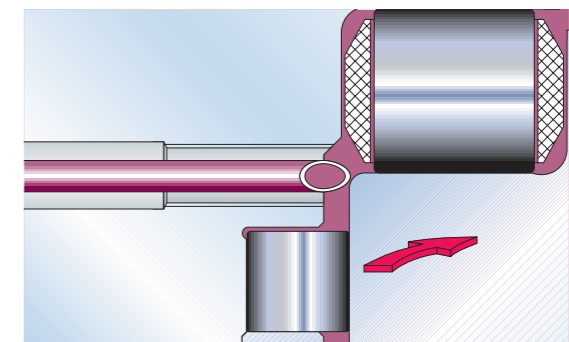

Figure 16: Detail of the sampling

Bearing inspection

Bearings without grease sampling ports

If there are no grease sampling ports provided on the bearing, one or more grease samples are taken at the seal. This area near a grease nipple must be cleaned. The sample should be taken preferably in the main working area and/or offset 180° to it.

During regreasing at the prepared grease nipple (without rotation of the bearing), the first grease escaping from the sealing lip is taken as the sample (figure 17). 3 ccm are enough.

Note Be careful when taking the sample or the result may be falsified by contamination.



Figure 17: Taking a sample of grease from the sealing lip

Fe limit values

A limit value for Fe contamination in the lubricant depends greatly on the operating parameters and the lubrication intervals. Depending on the application, the value can be as high as 20000 ppm.

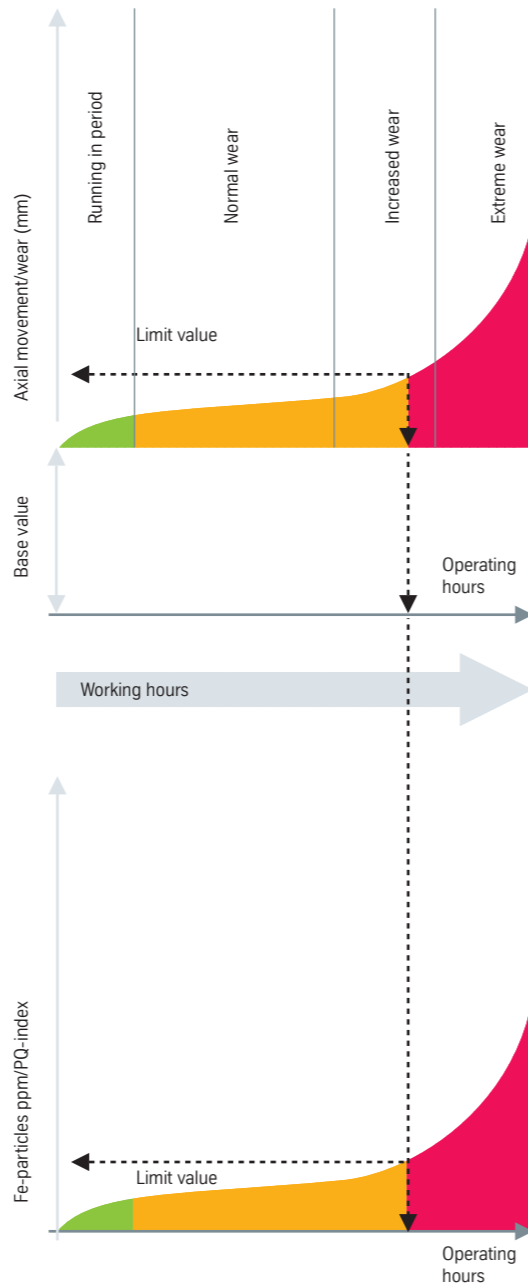

Figure 18: Wear curves

Wear curves

The diagrams show the increase in wear and the increases in Fe particles and the PQ index as a function of the operating hours (figure 18).

For standard applications see the values in tables 4-6 on page 13. When the limit values are reached, please contact thyssenkrupp rothe erde Germany GmbH.

Table 7: Measurement table

Customer		Application		Location				
thyssenkrupp rothe erde Germany GmbH drawing no.		thyssenkrupp rothe erde Germany GmbH order no.		Year of manufacture				
Date								
Operating hours								
Measuring point	Basic measurement	Repeated measurement (12 months interval)						
		1	2	3	4	5	6	7
1	Main load area 180° opposite							
2	Main load area 180° opposite							
3	Main load area 180° opposite							
4	Main load area 180° opposite							
Grease sample no.		1						
Fe particles ppm/ PQ index		2						
		3						
		4						
		5						
Grease								
Lubrication system Quantity/interval								
Comments								

The measurement values, analysis values and bearing-specific information should be entered in a separate table (see table 7) and forwarded to thyssenkrupp rothe erde Germany GmbH.

thyssenkrupp rothe erde Germany GmbH
Service
Beckumer Strasse 87
59555 Lippstadt
Germany
service.rotheerde@thyssenkrupp.com

thyssenkrupp rothe erde Germany GmbH sends the grease samples to an approved, qualified laboratory.

Advantage Short processing time and notification by e-mail about the analysis results and wear measurement.

For the **grease sampling** set please contact the following address:

thyssenkrupp rothe erde Germany GmbH
Tremoniastrasse 5-11
44137 Dortmund, Germany
Telephone +49 (2 31) 1 86 - 0
Telefax +49 (2 31) 1 86 -25 00
sales.rotheerde@thyssenkrupp.com

Disposal at end of useful life

ATTENTION	
	<p>Disposal may involve environmental risks</p> <ul style="list-style-type: none"> Follow the directives for waste disposal Mind the national laws

Bearing to be dismantled. Grease, seals and plastic parts to be disposed of in accordance with waste guidelines. Bearing rings and rolling elements to be taken to the relevant material recycling points.

Safety and warning instructions

Please refer to the detailed brochure "rothe erde® slewing bearings Installation - Lubrication - Maintenance / Bearing Inspection". It can be found at www.thyssenkrupp-rotheerde.com -> Download -> Technical Information. Failure to do so may result in damage.

Transport and handling

! DANGER	
	<p>Danger of life by overhead load</p> <ul style="list-style-type: none"> Do NOT step underneath the load Use suitable slings Use suitable lifting devices Suitable transport tap hole are stated in the bearing drawing



Lubricants, Bearings with grease sampling ports

! CAUTION	
	<p>Risk of skin irritation caused by lubricants</p> <ul style="list-style-type: none"> Safety gloves must be worn when handling lubricants Pay attention to the producer's data

Storage

ATTENTION	
	<p>Sensitive surface</p> <ul style="list-style-type: none"> Do not open the packing with a sharp blade Surface may be damaged

Checking of the raceway system

! DANGER		
	<p>Exceeding the maximum permissible wear rates involves the risk of accidents and danger of life</p> <ul style="list-style-type: none"> When reaching the wear limits the machine must be put out of operation 	

Installation

! CAUTION	
	<p>Risk of skin irritation caused by preservative</p> <ul style="list-style-type: none"> Safety gloves must be worn for removal Pay attention to the producer's data

SAFETY INSTRUCTIONS

- While in operation it must be assured that the wear limits of the bearing will not be reached. With regard to further information (sketches/procedures) see www.thyssenkrupp-rotheerde.com.
- The resulting wear must be regularly determined and recorded
- The procedure is included in the manual
- In case of open questions thyssenkrupp rothe erde Germany GmbH must be contacted

! DANGER

	<p>Entrapment hazard when putting the load down</p> <ul style="list-style-type: none"> Location control before putting the load down Mind the staff
---	--

Gearing

! DANGER	
	<p>Entanglement hazard due to exposed gear</p> <ul style="list-style-type: none"> Keep hands away from moving parts

Disposal at end of useful life

ATTENTION	
	<p>Disposal may involve environmental risks</p> <ul style="list-style-type: none"> Follow the directives for waste disposal Mind the national laws

Sicherheits- und Warnhinweise

Bitte beachten Sie die ausführliche Broschüre "rothe erde® slewing bearings Installation - Lubrication - Maintenance / Bearing Inspection". Diese finden Sie unter www.thyssenkrupp-rotheerde.com -> Download -> Technische Informationen. Bei Nichtbeachten kann ein Schaden entstehen.

Transport und Handling

! GEFAHR	
	<p>Lebensgefahr durch schwebende Last</p> <ul style="list-style-type: none"> NICHT unter die Last treten Geeignetes Anschlagmittel wählen Geeignetes Hebemittel wählen Geeignete Transportbohrungen sind in der Lagerzeichnung dargestellt

Schmierstoffe, Lager mit Fettentnahmebohrungen

! VORSICHT	
	<p>Mögliche Hautreizungen durch Schmierstoffe</p> <ul style="list-style-type: none"> Beim Umgang mit Schmierstoffen Handschuhe tragen Mitgeltende Unterlagen des Herstellers beachten

Einlagerung

HINWEIS	
	<p>Sensible Oberfläche</p> <ul style="list-style-type: none"> Nicht mit scharfem Messer die Verpackung öffnen Oberfläche kann beschädigt werden

Überprüfung des Laufsystems

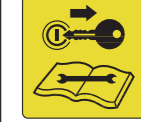
! GEFAHR		
	<p>Bei Überschreiten der maximal zulässigen Verschleißgrenzen besteht Unfall und Lebensgefahr</p> <ul style="list-style-type: none"> Bei Erreichen der Verschleißgrenzen ist das Gerät außer Betrieb zu setzen 	

Einbau

! VORSICHT	
	<p>Mögliche Hautreizungen durch Konservierungsmittel</p> <ul style="list-style-type: none"> Beim Entfernen Handschuhe tragen Mitgeltende Unterlagen des Herstellers beachten

SICHERHEITSHINWEISE

- Im Betrieb muss sichergestellt werden, dass die Verschleißgrenzen des Lagers nicht erreicht werden. Bezüglich weiterer Informationen (Skizzen/Prozeduren) siehe www.thyssenkrupp-rotheerde.com.
- Der eingetretene Verschleiß ist regelmäßig zu ermitteln und zu dokumentieren
- Die Vorgehensweise ist im Handbuch beschrieben
- Bei offen Fragen ist Rücksprache mit thyssenkrupp rothe erde Germany GmbH zu halten

! GEFAHR

	<p>Quetschgefahr beim Ablegen der Last</p> <ul style="list-style-type: none"> Vor dem Ablegen den Ablageort kontrollieren Auf Mitarbeiter achten
---	---

Verzahnung

! GEFAHR	
	<p>Quetschgefahr durch offenliegende Zahnräder</p> <ul style="list-style-type: none"> Nicht in den Wirkungsbereich greifen

Entsorgung nach Gebrauchsende

HINWEIS	
	<p>Bei der Entsorgung können Gefahren für die Umwelt entstehen</p> <ul style="list-style-type: none"> Abfallrichtlinien beachten Nationale Rechtsvorschriften beachten

Consignes de sécurité et avertissements

Prière d'observer la brochure détaillée intitulée « rothe erde® slewing bearings Montage - Graissage - Entretien / Inspección de coronnes ». Vous la trouverez sur www.thyssenkrupp-rotheerde.com -> Download -> Technische Informationen. Le non-respect de ces consignes risque de provoquer des dommages.

Transport et manutention

! DANGER	
	Danger de mort – Charge en suspension <ul style="list-style-type: none"> • NE PAS se placer sous la charge • Choisir des moyens d'élingage adéquats • Choisir des moyens de levage adéquats • Les trous de transport adéquats sont représentés sur le dessin de la couronne

Lubrifiants, Couronnes avec trous de prélèvement de graisse

! PRUDENCE	
	Certains lubrifiants peuvent entraîner des irritations cutanées <ul style="list-style-type: none"> • Porter des gants lors de la manipulation de lubrifiants. • Observer les autres documents applicables fournis par le fabricant

Stockage

REMARQUE	
	Surface sensible <ul style="list-style-type: none"> • Ne pas ouvrir l'emballage avec un couteau tranchant • La surface risque d'être endommagée

Contrôle du système de roulement

! DANGER	
	Risque d'accident et danger de mort en cas de dépassement des limites d'usure maximales admissibles <ul style="list-style-type: none"> • Mettre l'appareil hors service lorsque les limites d'usure sont atteintes

Montage

! PRUDENCE	
	Certains agents conservateurs peuvent entraîner des irritations cutanées <ul style="list-style-type: none"> • Porter des gants lors de l'enlèvement • Observer les autres documents applicables fournis par le fabricant

! DANGER	
	Risque d'écrasement à la dépose de la charge <ul style="list-style-type: none"> • Avant de la déposer, contrôler l'emplacement prévu • Vérifier qu'aucun collaborateur ne s'y trouve

CONSIGNES DE SÉCURITÉ	
	<ul style="list-style-type: none"> • En service, s'assurer que limites d'usure de la couronne ne soient pas atteintes. En ce qui concerne d'autres informations (croquis / procédures), voir www.thyssenkrupp-rotheerde.com. • Déterminer régulièrement l'usure survenue et la consigner sur document • La procédure à suivre est décrite dans le manuel • En cas de questions non éclaircies, prière de consulter thyssenkrupp rothe erde Germany GmbH

Denture

! DANGER	
	Risque d'écrasement dû aux roues dentées à découvert <ul style="list-style-type: none"> • Ne pas intervenir dans la zone d'action

Élimination après usage

REMARQUE	
	L'élimination peut entraîner des dangers pour l'environnement <ul style="list-style-type: none"> • Respecter les directives sur le traitement des déchets • Respecter les législations nationales

Instrucciones de seguridad y de advertencia

Observe el detallado folleto "rothe erde® slewing bearings Installation - Lubrication - Maintenance / Bearing Inspection" (Montaje - Lubricación - Mantenimiento (MLM) / Inspección de rodamiento) Lo encontrará en www.thyssenkrupp-rotheerde.com -> Descargas -> Información técnica. En caso de incumplimiento se pueden producir daños.

Transporte y manejo

! PELIGRO	
	Peligro de muerte por cargas en suspensión <ul style="list-style-type: none"> • ¡NO ponerse debajo de la carga! • Elegir el dispositivo de sujeción adecuado • Elegir el equipo de elevación adecuado • Los orificios de transporte adecuados vienen representados en el plano del rodamiento

Lubrificantes, Rodamiento con taladros para la toma de grasa

! PRECAUCIÓN	
	Los lubricantes pueden irritar la piel. <ul style="list-style-type: none"> • Llevar guantes a la hora de manipular lubricantes. • Tener en cuenta la documentación vigente del fabricante

Almacenamiento

ADVERTENCIA	
	Superficie delicada <ul style="list-style-type: none"> • No abrir el embalaje con un cuchillo afilado porque se podría dañar la superficie • La superficie podría resultar dañada

Comprobación del sistema de rodadura

! PELIGRO	
	Si se sobrepasan los límites de desgaste máximos permitidos existe peligro de accidente y de muerte <ul style="list-style-type: none"> • Si se sobrepasan los límites de desgaste, apagar el aparato

Montaje

! PRECAUCIÓN	
	Los conservantes pueden irritar la piel. <ul style="list-style-type: none"> • Llevar guantes al retirarlos. • Tener en cuenta la documentación d vigente del fabricante

! PELIGRO	
	Peligro de aplastamiento al depositar la carga <ul style="list-style-type: none"> • Controlar el lugar de colocación antes de depositarla • Asegurar que no haya empleados

INSTRUCCIONES DE SEGURIDAD	
	<ul style="list-style-type: none"> • Durante el servicio es preciso comprobar que no se alcancen los límites de desgaste del rodamiento. Para más información (figuras/procedimientos) ver www.thyssenkrupp-rotheerde.com. • Determinar y documentar periódicamente el desgaste producido • El procedimiento viene descrito en el manual • Si queda alguna pregunta pendiente, será preciso ponerse en contacto con thyssenkrupp rothe erde Germany GmbH

Dentado

! PELIGRO	
	Peligro de aplastamiento por ruedas dentadas al descubierto <ul style="list-style-type: none"> • No acceder a su radio de acción

Eliminación después del uso

ADVERTENCIA	
	La eliminación puede resultar nociva para el medio ambiente <ul style="list-style-type: none"> • Tener en cuenta la normativa nacional

Instruções de segurança e avisos

Por favor, observe a brochura detalhada "rothe erde® Montagem – Lubrificação – Manutenção (MLM) / Inspeção de rolamentos". Ela consta em www.thyssenkrupp-rotheerde.com -> Download -> Informações técnicas. Danos podem resultar em caso de inobservância.

Transporte e manuseio

! PERIGO	
	Perigo de morte por carga suspensa <ul style="list-style-type: none"> NÃO andar sob carga suspensa Selecionar meios de elevação adequados Selecionar um equipamento de elevação adequado Furos de transporte adequados estão indicados no desenho dos rolamentos

Lubrificantes, Rolamento com furos para coleta de graxa

! CUIDADO	
	Risco de irritações cutâneas possíveis causadas pelos lubrificantes <ul style="list-style-type: none"> Usar luvas para o manuseio de lubrificantes Observar a documentação vigente do fabricante

Armazenagem

NOTA	
	Superfície sensível <ul style="list-style-type: none"> Não abrir a embalagem com faca afiada A superfície pode ser danificada

Sistema de giro das pistas

! PERIGO	
	Em caso de serem excedidos os limites de desgaste máximos permissíveis, existe perigo de acidente e de morte <ul style="list-style-type: none"> Em caso de serem atingidos os limites de desgaste, o equipamento deve ser retirado de serviço

Montagem

! CUIDADO	
	Irritações cutâneas possíveis causadas pelo agente de conservação <ul style="list-style-type: none"> Usar luvas para a remoção Observar a documentação vigente do fabricante

INSTRUÇÕES DE SEGURANÇA

- É preciso assegurar que os limites de desgaste do rolamento não sejam atingidos durante o funcionamento. Com relação a outras informações (desenhos de projeto/procedimentos) vide www.thyssenkrupp-rotheerde.com.
- O desgaste ocorrido deve ser determinado e documentado regularmente
- O procedimento está descrito no manual
- Para as questões em aberto a thyssenkrupp rothe erde Germany GmbH deve ser consultada

! PERIGO

	Perigo de esmagamento ao pousar a carga <ul style="list-style-type: none"> Antes de pousar, controlar o lugar de deposição Ter em atenção os colaboradores
---	---

Engrenagem

! PERIGO	
	Perigo de esmagamento pelas engrenagens expostas <ul style="list-style-type: none"> Mantenha as mãos longe das partes móveis

Descarte após o fim de uso

NOTA	
	A eliminação pode produzir perigos para o meio ambiente <ul style="list-style-type: none"> Observar as diretivas sobre detritos Observar as disposições legais nacionais

Avvertenze e norme di sicurezza

Rispettare le indicazioni contenute nell'opuscolo "rothe erde® slewing bearings Montaggio - Lubrificazione - Manutenzione / Ispezione di cuscinetti", disponibile in www.thyssenkrupp-rotheerde.com -> Download -> Technical Information. In caso di mancato rispetto delle avvertenze possono insorgere danni.

Trasporto e movimentazione

! PERICOLO	
	Pericolo di morte per carichi sospesi <ul style="list-style-type: none"> NON passare sotto il carico sospeso Scegliere un mezzo di imbracatura adatto Scegliere un mezzo di sollevamento adatto I fori di trasporto adatti sono illustrati nel disegno del cuscinetto

Lubrificanti, Cuscinetti con fori di campionamento del grasso

! ATTENZIONE	
	Possibili irritazioni della pelle dovute ai lubrificanti <ul style="list-style-type: none"> Indossare i guanti quando si usano i lubrificanti Rispettare gli altri documenti validi del produttore

Immazzamento

AVVERTENZA	
	Superficie sensibile <ul style="list-style-type: none"> Non aprire l'imballaggio con un coltello affilato La superficie potrebbe danneggiarsi

Controllo del sistema di rotolamento

! PERICOLO	
	Pericolo di incidenti e di morte qualora vengano superati i limiti massimi ammissibili di usura <ul style="list-style-type: none"> Al raggiungimento dei limiti di usura mettere l'apparecchio fuori servizio

Montaggio

! ATTENZIONE	
	Possibili irritazioni della pelle dovute alla sostanza protettiva <ul style="list-style-type: none"> Indossare guanti per asportare la sostanza protettiva Rispettare gli altri documenti validi del produttore

NORME DI SICUREZZA

- In esercizio deve essere garantito che non siano raggiunti i limiti di usura del cuscinetto. Per altre informazioni (schizzi/procedure) vedere www.thyssenkrupp-rotheerde.com.
- Determinare e documentare regolarmente l'usura presente
- La procedura è descritta nel manuale
- In caso di problemi irrisolti, rivolgersi a thyssenkrupp rothe erde Germany GmbH

! PERICOLO

	Pericolo di schiacciamento mentre si depono il carico <ul style="list-style-type: none"> Controllare l'area in cui viene depositato il cuscinetto prima di appoggiarvi il carico Prestare attenzione ai collaboratori
---	--

Dentatura

! PERICOLO	
	Pericolo di schiacciamento per ingranaggi scoperti <ul style="list-style-type: none"> Non introdurre le mani nel raggio d'azione

Smaltimento a fine vita

AVVERTENZA	
	Lo smaltimento può comportare pericoli per l'ambiente <ul style="list-style-type: none"> Rispettare le direttive sullo smaltimento rifiuti Rispettare le norme nazionali di legge

Veiligheids- en waarschuwingsinstructies

Neem a.u.b. de uitvoerige brochure "rothe erde® slewing bearings Installation - Smering - Onderhoud/ Lagerinspectie" in acht. Dit vindt u onder www.thyssenkrupp-rotheerde.com -> Download -> Technische Informatie. Bij het niet in acht nemen kan schade ontstaan.

Transport en behandeling

! GEVAAR	
	Levensgevaar door hangende last <ul style="list-style-type: none"> Niet onder de last treden Geschikte aanslagmiddelen kiezen Geschikte hijsmiddelen kiezen Geschikte transportgaten zijn in de lagertekening weergegeven

Smeermiddelen, Lager met gaten voor vetmonsters

! VOORZICHTIG	
	Mogelijke huidirritatie door smeermiddelen <ul style="list-style-type: none"> Draag handschoenen bij de omgang met smeermiddelen Andere geldende documentatie van de fabrikant in acht nemen

Opslag

AANWIJZING	
	Gevoelig oppervlak <ul style="list-style-type: none"> Niet met scherp mes de verpakking openen Oppervlak kan beschadigd raken

Controle van het loopsysteem

! GEVAAR	
	Bij het overschrijden van de maximaal toelaatbare slijtagegrenzen is er gevaar voor ongevallen en levensgevaar <ul style="list-style-type: none"> Bij het bereiken van de slijtagegrenzen moet het apparaat buiten werking worden gezet

Montage

! VOORZICHTIG	
	Mogelijke huidirritatie door conserveringsmiddelen <ul style="list-style-type: none"> Bij het verwijderen handschoenen dragen Andere geldende documentatie van de fabrikant in acht nemen

! GEVAAR	
	Gevaar voor beknelling bij de neerlegging van de last <ul style="list-style-type: none"> Vóór het neerleggen de neerlegplaats controleren Op medewerkers letten

VEILIGHEIDSINSTRUCTIES

- Tijdens de werking moet worden gegarandeerd, dat de slijtagegrenzen van het lager niet worden bereikt. Met betrekking tot nadere informatie (tekeningen/procedures) zie www.thyssenkrupp-rotheerde.com.
- De opgetreden slijtage moet regelmatig gecontroleerd en gedocumenteerd worden
- De procedure is in het handboek beschreven
- Bij openstaande vragen moet thyssenkrupp rothe erde Germany GmbH worden geraadpleegd

Vertanding

! GEVAAR	
	Gevaar voor beknelling door vrijliggende tandwielen <ul style="list-style-type: none"> Niet in het werkbereik grijpen

Verwijdering na afloop van het gebruik

AANWIJZING	
	Bij de afvalverwijdering kunnen gevaren voor het milieu ontstaan <ul style="list-style-type: none"> Afvalrichtlijnen in acht nemen Nationale wettelijke voorschriften in acht nemen

Biztonsági előírások és figyelmeztetések

Kérjük, vegye figyelembe a teljes, "rothe erde® slewing bearings Installation - Lubrication - Maintenance / Bearing Inspection" című ("rothe erde® Gördülőcsapágyak felszerelése – kenése – karbantartása / a csapágyak ellenőrzése") brosúráját. Ez a www.thyssenkrupp-rotheerde.com honlapon -> Download -> Technische Informationen alatt található. Az előírások és figyelmeztetések figyelmen kívül hagyása károkhoz vezethet.

Szállítás és kezelés

! VESZÉLY	
	Függő teher okozta életveszély. <ul style="list-style-type: none"> NE lépjen a teher alá. Válassza ki a megfelelő kötözőelemet. Válassza ki a megfelelő emelőeszközt. A megfelelő szállítási furatok a csapágyrajzban kerültek ábrázolásra.

Kenőanyagok, Csapágyak zsírvevő furatokkal

! VIGYÁZAT	
	Kenőanyagok okozta esetleges bőrirritációk <ul style="list-style-type: none"> A kenőanyagokkal való bántáskor kesztyűt kell viselni Figyelembe kell venni a gyártó együtt érvényes dokumentumait

Beraktározás

FIGYELEM	
	Érzékeny felület <ul style="list-style-type: none"> Ne éles késsel bontsa fel a csomagolást A felület megsérülhet

A futórendszer ellenőrzése

! VESZÉLY	
	A maximálisan megengedett kopáshatárok túllépésekor fennáll a baleset- és életveszély <ul style="list-style-type: none"> A kopási határértékek elérésekor a készüléket üzemen kívül kell helyezni

Beszerelés

! VIGYÁZAT	
	Konzerváló anyagok okozta esetleges bőrirritációk <ul style="list-style-type: none"> Eltávolításkor kesztyűt kell viselni A gyártó együtt érvényes dokumentumai előírásait be kell tartani.

! VESZÉLY	
	Zúzódásveszély a szállítmány lerakásánál <ul style="list-style-type: none"> A lerakás előtt ellenőrizni kell a lerakási helyet. Vigyázni kell a munkatársak épségére.

BIZTONSÁGI FIGYELEMK

- Üzemelés közben biztosítani kell, hogy a csapágy a kopás-határait ne érje el. További információkra vonatkozóan (rajzok/procedúrák) lásd www.thyssenkrupp-rotheerde.com.
- A bekövetkezett kopást rendszeresen meg kell állapítani és dokumentálni
- Az eljárásmód a kézikönyvben van leírva
- A nyitott kérdéseket meg kell beszélni a thyssenkrupp rothe erde Germany GmbH céggel

Fogazat

! VESZÉLY	
	Burkolatlan fogaskerekek okozta zúzódásveszély <ul style="list-style-type: none"> Ne nyúljon a fogaskerek forgási területébe.

Ártalmatlanítás a használhatóság végén

FIGYELEM	
	A hulladékként ártalmatlanításkor veszélyek keletkezhetnek a környezet számára <ul style="list-style-type: none"> Vegye figyelembe a hulladékok ártalmatlanítására vonatkozó irányelveket Vegye figyelembe a nemzeti jogi előírásokat

Инструкции по технике безопасности и предупредительные указания

Просим обратить внимание на подробную информацию, представленную в брошюре «rothe erde® Установка опорно-поворотных устройств - Смазка - Уход / Инспекция подшипника». Эту брошюру можно найти здесь: www.thyssenkrupp-rotheerde.com -> Загрузка -> Техническая информация. При несоблюдении указаний могут возникнуть повреждения.

Транспортировка и хранение на складе

! ОПАСНОСТЬ	
	<p>Опасность со стороны подвешенного груза</p> <ul style="list-style-type: none"> НЕ ПРОХОДИТЬ под висящим грузом Выбирать подходящие строповочные средства Выбирать подходящие подъемные средства Необходимые транспортировочные отверстия показаны на чертеже подшипника

Смазочные материалы, Подшипник с отверстиями для взятия смазки

! ОСТОРОЖНО	
	<p>Возможны раздражения кожи, вызванные смазочным материалом</p> <ul style="list-style-type: none"> При работе со смазочными материалами использовать перчатки Соблюдать инструкции, изложенные в сопроводительной документации производителя

Хранение подшипников на складе

УКАЗАНИЕ	
	<p>Чувствительная поверхность</p> <ul style="list-style-type: none"> Не вскрывать упаковку острым ножом Это может привести к повреждению поверхности

Проверка рабочих элементов подшипника

! ОПАСНОСТЬ	
	<p>При превышении верхнего предела износа возникает риск аварии и опасность для жизни сотрудников</p> <ul style="list-style-type: none"> При достижении пределов износа следует прекратить эксплуатацию устройства

Монтаж

! ОСТОРОЖНО	
	<p>Риск раздражения кожи при контакте с консервационным материалом</p> <ul style="list-style-type: none"> При его удалении носить перчатки Соблюдать действующие документы изготовителя

ТЕХНИКА БЕЗОПАСНОСТИ

- Процесс эксплуатации следует организовать так, чтобы исключить вероятность достижения предела износа подшипника. Дополнительную информацию (эскизы/процедуры) см. на сайте www.thyssenkrupp-rotheerde.com.
- Текущий износ следует регулярно проверять и документировать
- Порядок действий описан в руководстве
- Со всеми вопросами следует обращаться в [thyssenkrupp rothe erde Germany GmbH](http://thyssenkrupp-rotheerde.com)

! ОПАСНОСТЬ	
	<p>Опасность повреждения при опускании груза</p> <ul style="list-style-type: none"> Перед опусканием груза проверить место опускания Следить за местонахождением других сотрудников

Зубчатое зацепление

! ОПАСНОСТЬ	
	<p>Опасность сдавливания со стороны раскрытых зубчатых колес</p> <ul style="list-style-type: none"> Не совать руки в зону их вращения

Утилизация после истечения срока службы

УКАЗАНИЕ	
	<p>При утилизации могут возникнуть опасности для окружающей среды</p> <ul style="list-style-type: none"> Соблюдать предписания по утилизации Соблюдать национальные нормативные инструкции

安全与警告说明

请您注意详细的宣传手册《rothe erde® slewing bearings 安装 - 润滑 - 维护保养 Bearing Inspection》一章。您可以通过以下方式找到该手册: www.thyssenkrupp-rotheerde.com -> 下载 -> 技术信息。如不遵守规定可导致严重损失。

运输与搬运

! 危险	
	<p>悬空重物会造成生命危险</p> <ul style="list-style-type: none"> 不得在重物下方通行及逗留 选择适宜的吊具 选择适宜的起重设备 适宜的运输孔在回转支承图纸中有描述

润滑材料, 具有油脂取样孔的支承

! 注意	
	<p>润滑油脂可能会刺激皮肤</p> <ul style="list-style-type: none"> 进行与润滑油脂相关的操作时须戴手套 须遵守适用的生产商资料

贮存

说明	
	<p>敏感的表面</p> <ul style="list-style-type: none"> 不得用锋利的刀具打开包装 可能导致表面受损

检测滚道系统

! 危险	
	<p>若超出允许的磨损极限值则会发生事故和造成人身伤亡的危险</p> <ul style="list-style-type: none"> 达到磨损极限值时必须将设备停用

安装

! 注意	
	<p>防腐剂可能会刺激皮肤</p> <ul style="list-style-type: none"> 去除防腐剂时须戴手套 须遵守适用的生产商资料

安全提示

- 运营者必须避免支承达到磨损极限。
- 其他信息 (图纸/流程) 请见 www.thyssenkrupp-rotheerde.com。
- 必须定期查明并记录磨损程度
- 操作方式请见手册
- 对于未解决的问题请向 [thyssenkrupp rothe erde Germany GmbH](http://thyssenkrupp-rotheerde.com) 咨询

! 危险	
	<p>卸载重物时会出现挤压危险</p> <ul style="list-style-type: none"> 卸载重物前须检查卸载地点 须注意同事的安全

啮合

! 危险	
	<p>暴露在外的齿轮可能造成卷入危险</p> <ul style="list-style-type: none"> 手指远离正在转动的齿轮

报废后废物处理

说明	
	<p>废物处理可能对环境造成危害</p> <ul style="list-style-type: none"> 须遵守废物处理规定 须遵守相关国家法规

安全上の注意及び警告

完全版パンフレット、「rothe erde® 旋回ベアリングの取り付け・潤滑・メンテナンス/ベアリングの点検」をよくお読みください。このパンフレットはwww.thyssenkrupp-rotheerde.com の「ダウンロード」ページの「技術情報」からダウンロードできます。注意事項を守らないと損傷が起きることがあります。

輸送と取扱いについて

危険



吊り荷の下は生命の危険

- 吊り荷の下に入らないで下さい
- 適切なロープを使用して下さい
- 適切な吊り具を使用して下さい
- 運搬用穴はベアリング設計図に記載されています

潤滑油、潤滑油採取穴付きベアリング

警告



潤滑油による皮膚への刺激

- 潤滑油を取扱う際には手袋を着用して下さい
- メーカーの説明書を確認して下さい

保管

注意



傷つきやすい表面

- 鋭いナイフでパッケージを開けないで下さい
- 表面が損傷する恐れがあります

レース面の点検

危険



摩耗限界に達した場合、生命が危ぶまれる事故が発生する可能性があります

- 摩耗限界に達した場合、装置を止めて下さい



据付

注意



防錆剤により皮膚への刺激

- 除去する際には手袋を着用して下さい
- メーカーの説明書を確認して下さい

安全に関する注意

- 稼働中にベアリングの摩耗限界に達してはなりません。詳しくは www.thyssenkrupp-rotheerde.com を参照ください。
- 摩耗が発生した場合は、定期的に調査し記録して下さい
- 手順はマニュアルに記載されています
- ご質問、お問い合わせは thyssenkrupp rothe erde Germany GmbH へ連絡下さい

危険



荷下ろしの際下敷きになる危険

- 荷下ろしの前に置き場所を確認して下さい
- 人がいないか確認して下さい

リングギア

危険



むき出しの歯車に手を挟まれる危険

- かみ合わせ部分に手を入れないで下さい

使用後の廃棄処分

注意



廃棄処分の際、環境に悪影響を及ぼす可能性があります

- 廃棄物ガイドラインを確認して下さい
- 国内法を遵守して下さい

انحذيرات وجعهي أت انسلاية

يزجي انزجوع إني انكحيب ان قُصم "يحايم اندورا ي rothe erde® انحرقيب، انحشدي، انصباة / فحص ان حُ" وانذي ججدو ه جحت انزابط < Download > rotheerde.com-www.thyssenkrupp (ج زيم) < Technical Information > يعهويات جق ية. حيث ي ك أ ج شأ أضزار ع ذ عدو الايحتال ن أ يزد فيه.

مواد التشحيم محامل مع منافذ لسحب عينات الشحم

ملحوظة



قد يتعرض الجلد لتهيجات بسبب مواد التشحيم

- يجب ارتداء قفازات اليد عند التعامل مع مواد التشحيم
- برجاء مراعاة مستندات الشركة المصنعة المرفقة

النقل والتعامل

خطر



خطر على الحياة بسبب الحمل المعلق

- لا تدخل تحت الحمل
- اختر الرافعة المناسبة
- اختر معدات الرفع المناسبة
- فتحات النقل المناسبة معروضة في رسوم المحمل

فحص نظام مجرى الكريات

خطر



في حالة تجاوز حدود التآكل المسموح بها ينشأ خطر وقوع حوادث وخطر الموت

- عند الوصول إلى حدود التآكل يجب إيقاف الجهاز عن العمل



التخزين

ملحوظة



سطح حساس

- لا تفتح العبوات باستخدام سكين حاد
- قد تتعرض الأسطح للتلف

تعليمات السلامة

- خلال التشغيل يجب التأكد من عدم تجاوز حدود تآكل المحمل، وللحصول على مزيد من المعلومات (تخطيطات/إجراءات) انظر الموقع الإلكتروني www.thyssenkrupp-rotheerde.com.
- يجب الكشف بانتظام عن معدل التآكل الحادث وتوثيقه
- الإجراءات موصوفة في الدليل
- في حالة وجود أي مواضيع غير محسومة يمكنك التشاور مع شركة thyssenkrupp rothe erde Germany GmbH

التركيب

ملحوظة



قد يتعرض الجلد لتهيجات بسبب المواد الحافظة

- يجب ارتداء قفازات اليد عند الإزالة
- برجاء مراعاة مستندات الشركة المصنعة المرفقة

خطر



خطر التعرض للسحق عند إززال الحمل

- يجب التحقق من موضع الإنزال قبل بدء الإنزال
- يجب الانتباه لوجود موظفين

التخلص من الجهاز بعد انتهاء الاستخدام

ملحوظة



عند التخلص من الجهاز قد تنشأ مخاطر على البيئة

- برجاء مراعاة توجيهات التخلص من النفايات
- برجاء مراعاة اللوائح القانونية المحلية

مجموعة المسننات

خطر



خطر التعرض للسحق بسبب التروس المسننة المكشوفة

- لا تدخل في منطقة التأثير

Europe

thyssenkrupp rothe erde Germany GmbH
Tremoniastraße 5-11
44137 Dortmund
Germany
Tel.: +49 (0) 231 1 86 0
Fax: +49 (0) 231 1 86 25 00
www.thyssenkrupp-rotheerde.com

Werk Lippstadt
Beckumer Str. 87
59555 Lippstadt
Germany
Tel.: +49 (0) 29 41 7 41 0
Fax: +49 (0) 29 41 7 41 33 20

Werk Eberswalde
Heegermühler Straße 64
16225 Eberswalde
Germany
Tel.: +49 (0) 33 34 2 06 4 00
Fax: +49 (0) 33 34 2 06 4 90

thyssenkrupp rothe erde Italy S.p.A.
Viale Kennedy, 56
25010 Visano (Brescia)
Italy
Tel.: +39 342 866 00 10
Fax: +39 030 5785 178

thyssenkrupp rothe erde UK Ltd.
Mill Hill, Northwest Industrial Estate
Peterlee, Co. Durham, SR8 2HR
Great Britain
Tel.: +44 (1 91) 5 18 56 00
Fax: +44 (1 91) 5 86 90 96

thyssenkrupp rothe erde Slovakia a.s.
Robotnícka ul.
01701 Považská Bystrica
Slovakia
Tel: +421 42 4371 111
Fax: +421 42 4326 644

thyssenkrupp rothe erde Spain S.A.
Carretera Castellón, km. 7
Polígono Industrial "La Cartuja"
50720 La Cartuja Baja (Zaragoza)
Spain
Tel.: +34 (9 76) 50 04 80
Fax: +34 (9 76) 50 01 54

Asia

thyssenkrupp rothe erde (Xuzhou)
Ring Mill Co. Ltd.
Luoshan road 6
Xuzhou Economic and Technological
Development Zone
Jiangsu, 221004
China
Tel.: +86 (5 16) 87 98 01 01
Fax: +86 (5 16) 87 98 01 02

Xuzhou Rothe Erde
Slewing Bearing Co. Ltd.
Luoshan Road 15
Xuzhou Economic and Technological
Development Zone
Jiangsu, 221004
China
Tel.: +86 (5 16) 87 76 71 70
Fax: +86 (5 16) 87 76 89 46

Rothe Erde India Private Ltd.
Gat No. 429,
Village: Wadivarhe, Post: Gonde,
Taluka: Igatpuri, District: Nashik,
Maharashtra, PIN 422 403
India
Tel.: +91 (25 53) 30 22 31
Fax: +91 (25 53) 30 23 00

thyssenkrupp rothe erde Japan Ltd.
Akasaka Garden City Bldg. 17th Floor
4-15-1 Akasaka
Minato-Ku/Tokyo
Zip 107-0052
Japan
Tel.: +81 (3) 55 72 06 81
Fax: +81 (3) 55 72 06 80

America

thyssenkrupp Brasil Ltda. –
Division rothe erde
Rua Lidia Blank, No. 48
CEP 09913-010 Diadema, São Paulo
Brasil
Tel.: +55 (11) 40 55 84 00
Fax: +55 (11) 40 55 38 92

thyssenkrupp rothe erde USA Inc.
1400 South Chillicothe Rd.
P.O. Box 312
Aurora, Ohio 44202
USA
Tel.: +1 (3 30) 5 62 40 00
Fax: +1 (3 30) 5 62 46 20